

## **München Solar Installation Manual**

© München Energieprodukte GmbH  
[www.muenchen-energieprodukte.de](http://www.muenchen-energieprodukte.de)

## Contents

1. Safety .....	2
1.1. General safety.....	2
1.2. Operation safety .....	2
1.3. Installation safety.....	3
1.4. Fire Safety .....	4
2. Product Identification .....	5
3. Mechanical installation .....	6
3.1. Selecting the location.....	6
3.2. General Installation .....	6
3.3. Installation methods .....	7
3.4. Attachment guidelines .....	8
4. Electrical installation .....	14
4.1. Electrical property.....	14
4.2. General installation .....	16
4.3. Grounding.....	17
5. Maintenance .....	19

## 1. Safety

### 1.1. General safety

- Modules that fall under this application class may be used in system operation at more than 50V DC or 240W, where general contact access is anticipated. Modules qualified for safety under IEC 61730-2 and within this application class are considered to meet the requirements for Safety Class II. (IEC Only).
- PV modules are recommended to be installed at altitudes of less than 2000m.
- Installing solar photovoltaic systems requires specialized skills and knowledge. Installation must only be performed by authorized and trained personnel.
- Installers must assume all risks of injury that might occur during installation, including, but not limited to, the risk of electric shock.
- One single module may generate more than 30V DC when exposed to direct sunlight. Contact with a DC voltage is potentially hazardous and should be always avoid.
- Do not disconnect the modules or any electrical part under load. PV modules generate electricity when exposed to sunlight.
- Number of modules string connected can cause lethal shock and burn hazards. Only authorized and trained person should have access to the modules.
- Photovoltaic solar modules convert light energy to direct current electrical energy. They are designed for outdoor use. Modules can be ground mounted, mounted on rooftops. The proper design of support structures lies within the responsibility of the system designers and installers.
- When installing the system, abide to all local, regional and national statutory regulations. Obtain a building permit if necessary.
- The electrical characteristics are within  $\pm 3$  percent of the indicated values of  $I_{sc}$ ,  $V_{oc}$  and  $P_{max}$  under standard test conditions (irradiance of 1000 W/m<sup>2</sup>, AM 1.5 spectrum, and a cell temperature of 25 °C/77 °F).
- Only use equipment, connectors, wiring and support frames suitable for solar electric systems.
- Do not use mirrors, other magnifiers or artificially concentrated sunlight onto the modules.
- Always use fall protection equipment when working from heights of 6 feet (183cm) or above. Follow Occupational Safety and Health Act (OSHA) or local governing safety regulations regarding Fall Protection. (UL Only)
- Do not sit, stand, step or walk on any side of the module, including the frames.
- Do not permit any part of the module(s) to be submerged or allow for constant water to soil the module(s) unless it's natural rain fall or periodic cleaning.
- Do not permit constant dew on any part of back-sheet of the module.

2

### 1.2. Operation safety

- Do not lift the module by holding the module's junction box or electrical leads.

- Do not place any heavy or sharp objects on the module.
- Be cautious when placing the module down onto a surface, particularly when placing it in a corner.
- Inappropriate transport and installation may break the module and void the warranty.
- Do not attempt to disassemble the modules, and do not remove any attached nameplates or components from the modules.
- Do not apply paint or adhesive to the module top surface or back-sheet.
- To avoid damage to the back-sheet and cells, do not scratch, dent or hit the back-sheet. During the transportation,
- Do not to apply direct pressure on the back-sheet or front glass. Do not drill holes in the frame. This may compromise the frame strength, cause corrosion of the frame and void the warranty.
- Do not scratch the anodized coating of the frame (except for grounding connections at the grounding connection point on the back side of the module). It may cause corrosion of the frame or compromise the frame strength.
- A module with broken glass or torn back-sheet cannot be repaired and must not be used since contact with any module surface or the frame can cause an electric shock.
- Work only under dry conditions, and use only dry tools. Do not handle modules under wet conditions unless wearing appropriate protective equipment.
- When storing uninstalled modules outdoors for any period of time, always cover the modules and ensure that the glass faces down on a soft flat surface to prevent water from collecting inside the module and causing damage to exposed connectors.

### 1.3. Installation safety

- Never disconnect electrical connections or unplug connectors while the circuit is under load.
- Contact with electrically active parts of the modules, such as terminals, can result in burns, sparks and lethal shock whether or not the module is connected.
- Do not touch the PV module unnecessarily during installation. The glass surface and the frame may be hot; there is a risk of burns and electric shock.
- Do not work in the rain, snow or in windy conditions.
- Avoid exposing cables and connectors to direct sunlight and scratches or cuts in order to prevent insulation degradation. Use only insulated tools that are approved for working on electrical installations.
- Keep children well away from the system while transporting and installing mechanical and electrical components. Completely cover the module with an opaque material during installation to prevent electricity from being generated.
- Do not wear metallic rings, watchbands, earrings, nose rings, lip rings or other metallic objects while installing or troubleshooting photovoltaic systems.
- Follow the safety regulations (e.g., safety rules for working on electrical power plant stations) of your regions and for all other system components, including wires and cables, connectors, charging regulators, inverters, storage batteries, rechargeable batteries, etc.

- 
- Under normal conditions, a photovoltaic module is likely to experience conditions that produce more current and/or voltage than reported at standard test conditions. Accordingly, the values of  $I_{sc}$  and  $V_{oc}$  marked on this module should be multiplied by a factor of 1.25 when determining component voltage ratings, conductor current ratings, minimum factor of fuse sizes, and size of controls connected to the PV output.
  - Only use same connectors to connect modules to form a string, or connect to another device. Removing the connectors will void the warranty.

## **1.4. Fire Safety**

- Consult your local authority for guidelines and requirements for building or structural fire safety.
- Roof constructions and installations may affect the fire safety of a building; improper installation may create hazards in the event of a fire.
- Use components such as ground fault circuit breakers and fuses as required by local authority. Do not use modules near equipment or in places where flammable gases may be generated. The modules have been rated Fire Class C, and are suitable for mounting on to a Class A roof.

## 2. Product Identification

Each module has two labels providing the following information:

1. Nameplate: describes the product type; rated power, rated current, rated voltage, open circuit voltage, short circuit current, all as measured under standard test conditions; weight, dimensions etc.; the maximum system voltage is 600 volts or 1000 volts depending on the product family DC for UL standard and 1000/1500 volts DC for IEC standard. Depending on the products some are UL/IEC listed to 1000/1500 volts while other UL products are 600 volts. Check your nameplate or contact your local representative for details.
2. Barcode: each individual module has a unique serial number. The serial number has 17 digits. The 9th and 10th digits are year codes, and the 11th and 12th digits are weekly codes. For example, 7755S105201000001 means that the module is assembled and inspected in the 10th week of 2010. Each module has only one bar code. It is permanently attached to the interior of the module and is visible from the top front of the module. This bar code is inserted prior to laminating.



Example barcode label

*Do not remove any labels. Removing a label will make the modul warranty void.*

## 3. Mechanical installation

### 3.1. Selecting the location

Select a suitable location for installing the modules.

The modules should face south in northern latitudes and north in southern latitudes.

For detailed information on the best installation angle, refer to standard solar photovoltaic installation guides or consult a reputable solar installer or systems integrator.

Modules should not be shaded at any time. If a module is shaded or even partially shaded, it will fail to perform at ideal conditions and result in lower power output. A permanent and/or regular shade on the module voids the warranty.

This installation manual is applicable for all PV system of 500 m or more away from the coastline.

Do not use modules near equipment or in locations where flammable gases may be generated or collected.

### 3.2. General Installation

Before installing modules check for any optical deviations. Any optical deviations noticed after system installed may void warranty. Any potential costs for labor, material or other cost such as documentation, safety or performing the (de/ re-) installation will not be covered.

The module mounting structure must be made of durable, corrosion-resistant and UV-resistant material. Always use a tested and certified mounting structure approved for your system design.

In regions with heavy snowfall in winter, select the height of the mounting system so that the lowest edge of the module is not covered by snow for any length of time. In addition, ensure that the lowest portion of the module is placed high enough so that it is not shaded by plants, trees or damaged by ground soil moved by or through the air.

For ground mounting systems, the minimum distance we recommend from the ground to the bottom of the module is at least 24 inches (60cm).

Modules must be securely attached to the mounting structure. For Clamping System installation methods, the recommended maximum compression for each clamp is 2900 PSI (20 MPA) in order to avoid potential damages to module frames. Follow the instruction of the clamping system supplier.

Provide adequate ventilation under the modules in conformity to your local regulations. A minimum distance of 10 cm between the roof plane and the frame of the module is generally recommended.

Always observe the instructions and safety precautions included with the module support frames.

Before installing modules on a roof, always ensure the roof construction is suitable. In addition, any roof penetration required to mount the module must be properly sealed to prevent leaks.

Dust building up on the surface of the module can impair with the module performance. The modules shall

be installed with a tilt angle no less than 10 degrees, making it easier for dust to be removed by rain. A flat angle requires more frequent cleaning.

Observe and take into account the linear thermal expansion of the module frames (the recommended minimum distance between two modules is 2 cm).

Always keep the front and back-sheet of the module free from other objects, plants and vegetation, structural elements, which could come into contact with the module, especially when the module is under mechanical load.

When installing a module on a pole, select a pole and module mounting structure that will withstand the anticipated wind load and snow load for the area.

Ensure modules are not subjected to wind or snow loads exceeding the maximum permissible loads, and are not subject to excessive forces due to the thermal expansion of the support structures. Never allow modules overlap or exceeds the rooftop: Refer to the following installation methods for more detailed information.

### 3.3. Installation methods

Modules can be installed on the frame using mounting holes, clamps\* or an insertion system. Modules must be installed according to the following examples. Not mounting the modules according to these instructions may void the warranty.

7

Module can be installed in both landscape and portrait modes.

The modules must be properly secured to their support so that they can withstand live load conditions, including positive and negative load, to the pressure they have been certified for. It is the installer's responsibility to ensure that the clamps used to secure the modules are strong enough.

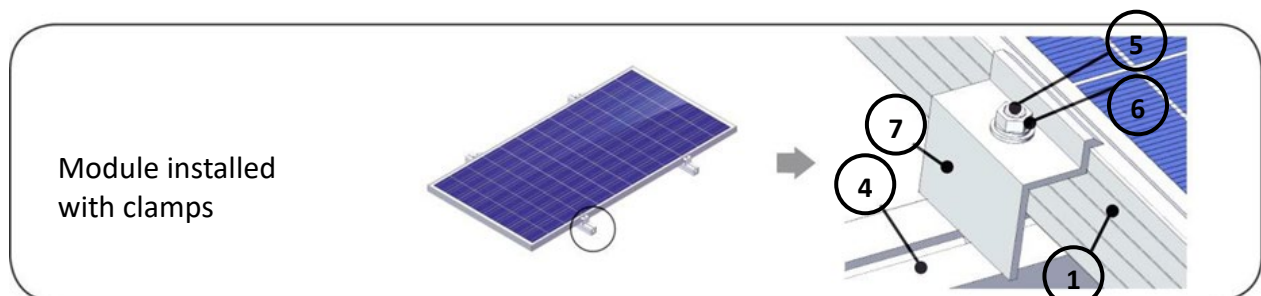
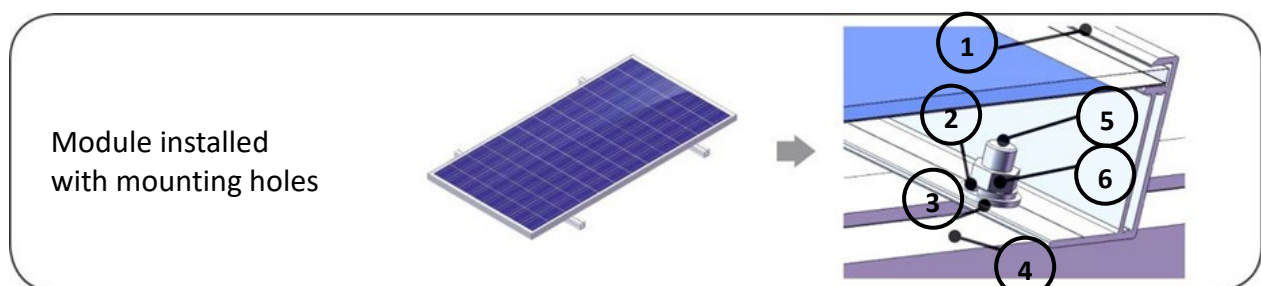



1	Modulframe	5	Bolt M8
2	Split Washer	6	Nut M8
3	Flat Washer	7	Clamps
4	Mounting structure		

Module can be installed in both landscape and portrait modes.

The modules must be properly secured to their support so that they can withstand live load conditions, including positive and negative load, to the pressure they have been certified for. It is the installer's responsibility to ensure that the clamps used to secure the modules are strong enough.

### 3.4. Attachment guidelines

Select the proper installation method depending on the load (See below for more detailed information).

With different installation methods, the modules have been tested to withstand the loads of 2400 Pa, 3800 Pa and 5400 Pa according to IEC 61215 standard, equivalent of 1600 Pa (0.232psi), 2500 Pa (0.363 psi) and 3600 Pa (0.522 psi) respectively under UL 1703 standard.

The diagrams in the tables below are designed for illustration purpose. For each installation, modules can be installed either in portrait or landscape mode. If you integrate our obsolete products and need advice, please contact München Energieprodukte GmbH, Customer Support Department for installation instructions based on older manuals.

München Solar Modul Typ	Zelltyp	Modulgröße
MSMDxxxM2-30	156.75 Vollzellen	1640x992x35/40 mm
MSMDxxxM2-36	156.75 Vollzellen	1956x992x40 mm
MSMDxxxM3-30	158.75 Vollzellen	1665x1002x35/40 mm
MSMDxxxM3-36	158.75 Vollzellen	1980x1002x40 mm
MSMDxxxM3-60	158.75 Halbzellen	1684x1002x35/40 mm
MSMDxxxM3-72	158.75 Halbzellen	2008x1002x40 mm
MSMDxxxM6-60	166 Halbzellen	1765x1048x35/40 mm
MSMDxxxM6-72	166 Halbzellen	2108x1048x35/40 mm
MSMDxxxM10-60	182 Halbzellen	1916x1134x35 mm
MSMDxxxM10-72	182 Halbzellen	2279x1134x35 mm

## Recommend Mounting Method

### Installation



### Mechanical load

**Test load:**  
positive 2400 Pa  
negative 2400 Pa  
**Design load:**  
positive 1600 Pa  
negative 1600 Pa  
safety factor: 1.5

### Modul Type

M2-30 series  
M3-30 series  
M3-60 series  
M6-60 series

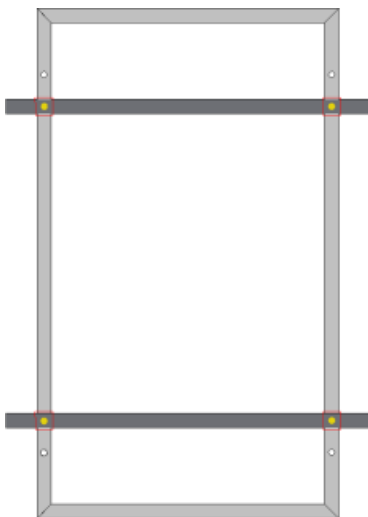

**Test load:**  
positive 5400 Pa  
negative 2400 Pa  
**Design load:**  
positive 3600 Pa  
negative 1600 Pa  
safety factor: 1.5

M2-30 series  
M3-30 series  
M3-60 series  
M6-60 series

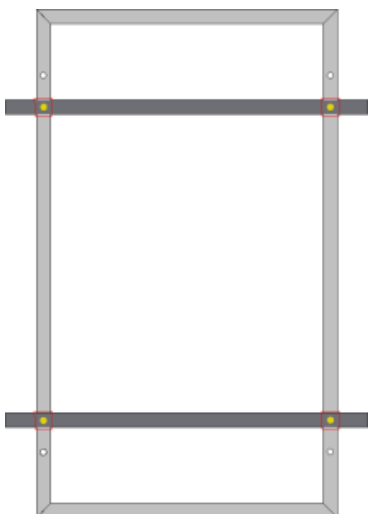

**Test load:**  
positive 5400 Pa  
negative 3800 Pa  
**Design load:**  
positive 3600 Pa  
negative 2533Pa  
safety factor: 1.5

M3-36 series  
M2-36 series

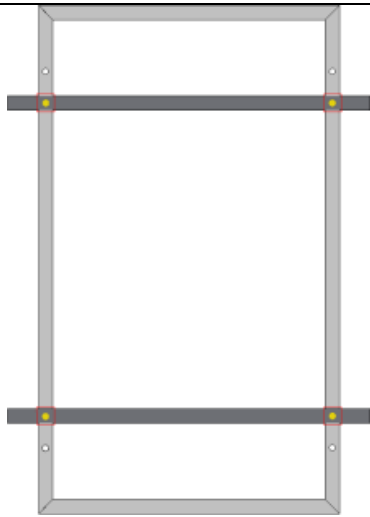

**Test load:**  
 positive 5400 Pa  
 negative 2400 Pa  
**Design load:**  
 positive 3600 Pa  
 negative 1600 Pa  
 safety factor: 1.5

M6-60 series  
 M6-72 series  
 M10-60 series  
 M10-72 series

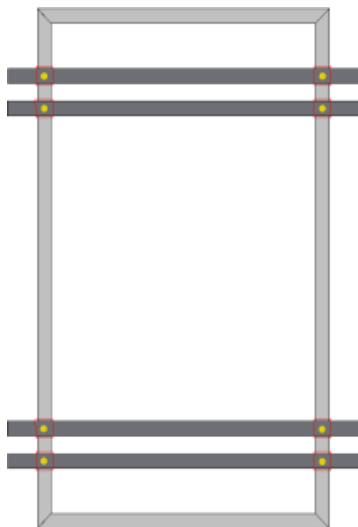

**Test load:**  
 positive 5400 Pa  
 negative 3800 Pa  
**Design load:**  
 positive 3600 Pa  
 negative 2533Pa  
 safety factor: 1,5

M2-30 series  
 M3-30 series  
 M3-60 series  
 M6-60 series  
 M6-72 series  
 M10-60 series  
 M10-72 series

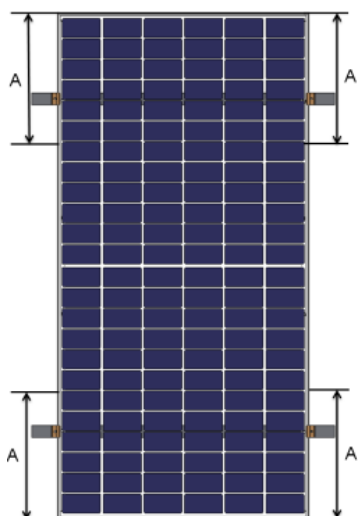

Clamp zone:  $A=1/4$   
 long frame length  $\pm 50$  mm

**Test load:**  
 positive 2400 Pa  
 negative 2400 Pa  
**Design load:**  
 positive 1600 Pa  
 negative 1600 Pa  
 safety factor: 1,5

M2-30 series  
 M2-36 series  
 M3-30 series  
 M3-36 series  
 M3-60 series  
 M6-60 series

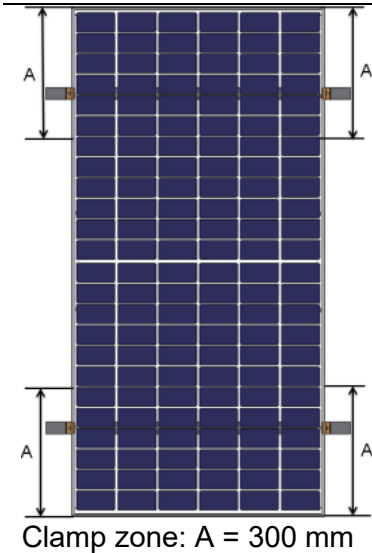

Clamp zone: A = 300 mm

**Test load:**  
positive 5400 Pa  
negative 3800 Pa  
**Design load:**  
positive 3600 Pa  
negative 2533Pa  
safety factor: 1,5

M2-36 series  
M3-36 series

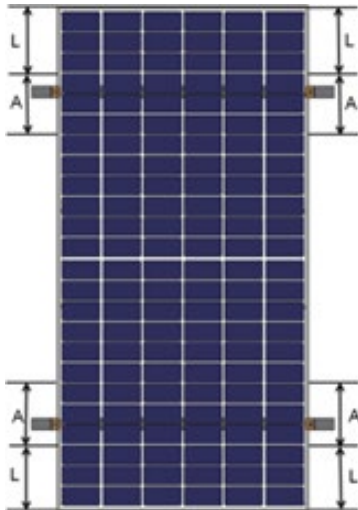

lamp zone: A = 200 mm

**Test load:**  
positive 5400 Pa  
negative 3800 Pa  
**Design load:**  
positive 3600 Pa  
negative 2533Pa  
safety factor: 1,5

M6-60 series  
M6-72 series  
M10-60 series  
M10-72 series

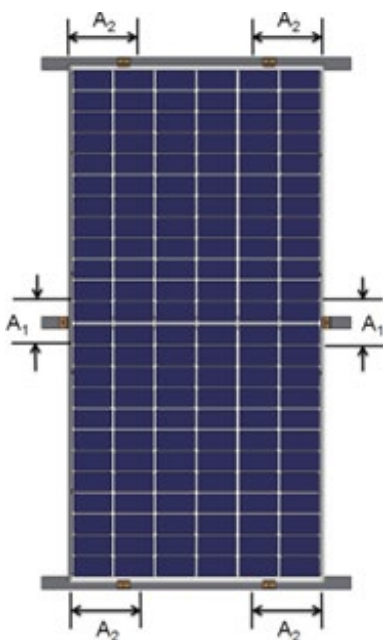

Clamp zone:  
A0 = 1/4 short frame length  $\pm 50$  mm  
A1 = 100 mm

**Test load:**  
positive 5400 Pa  
negative 3800 Pa  
**Design load:**  
positive 3600 Pa  
negative 2533 Pa  
safety factor: 1,5

M2-30 series  
M3-30 series  
M3-60 series  
M6-60 series  
M6-72 series  
M10-60 series  
M10-72 series

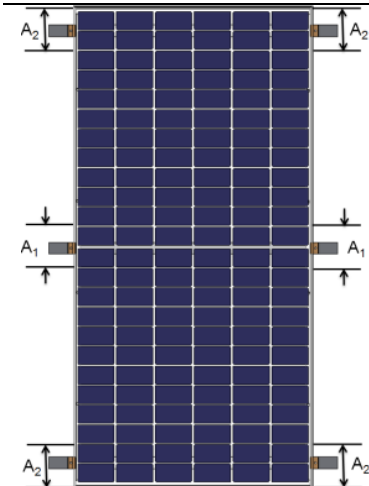

Clamp zone: A1 = 100 mm  
A2 = 200 mm

**Test load:**  
positive 5400 Pa  
negative 3800 Pa  
**Design load:**  
positive 3600 Pa  
negative 2533 Pa  
safety factor: 1,5

M2-30 series  
M3-30 series  
M3-60 series  
M6-60 series  
M6-72 series  
M10-60 series  
M10-72 series

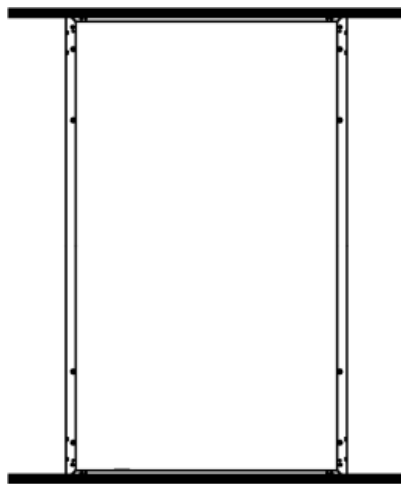

**Test load:**  
positive 2400 Pa  
negative 2400 Pa  
**Design load:**  
positive 1600 Pa  
negative 1600 Pa  
safety factor: 1,5

M2-30 series  
M3-30 series  
M3-60 series  
M6-60 series

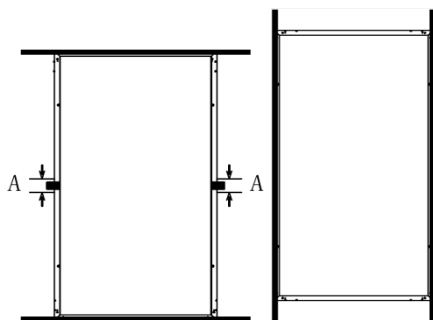

Clamp zone: A = 100 mm

**Test load:**  
positive 5400 Pa  
negative 3800 Pa  
**Design load:**  
positive 3600 Pa  
negative 2533 Pa  
safety factor: 1,5

M2-30 series  
M3-30 series  
M3-60 series  
M6-60 series  
M6-72 series  
M10-60 series  
M10-72 series

Attentions:

- The module clamps must not come into contact with the front glass or deform the frame in any way. Avoid shading effects from the module clamps and insertion systems. Drainage holes in the module frame must not be closed or obscured by the clamps.
- The loads of 2400 Pa, 3800 Pa and 5400 Pa are under IEC standard. The installation methods applicable for 5400 Pa are also relevant for 3800 Pa and 2400 Pa. The installation methods applicable for 3800 Pa are also relevant for 2400 Pa.

- The mounting holes reserved for tracker mounting system with special accessories. The length of module is over 2 meters, whose load value with tracker needsto be confirmed by module supplier respectively.

## 4. Electrical installation

### 4.1. Electrical property

Module under standard testing conditions of: irradiance of 1000W /m<sup>2</sup>, cell temperature of 25 °C and air mass of AM1.5, maximum over-current protection is 15A.

Under normal conditions, a Photovoltaic module is likely to experience conditions that produce more current and/or voltage than reported at standard test conditions. Accordingly, the values of I<sub>sc</sub> and V<sub>oc</sub> marked on this module should be multiplied by a factor of 1.25 when determining component voltage ratings, conductor ampacities, fuse sizes, and size of controls connected to the PV output.

Voltages are additive when modules are connected in series, and modules currents are additive when Modules are connected in parallel, as illustrated in Figure 1.

Modules with different electrical characteristics must not be connected directly in series.

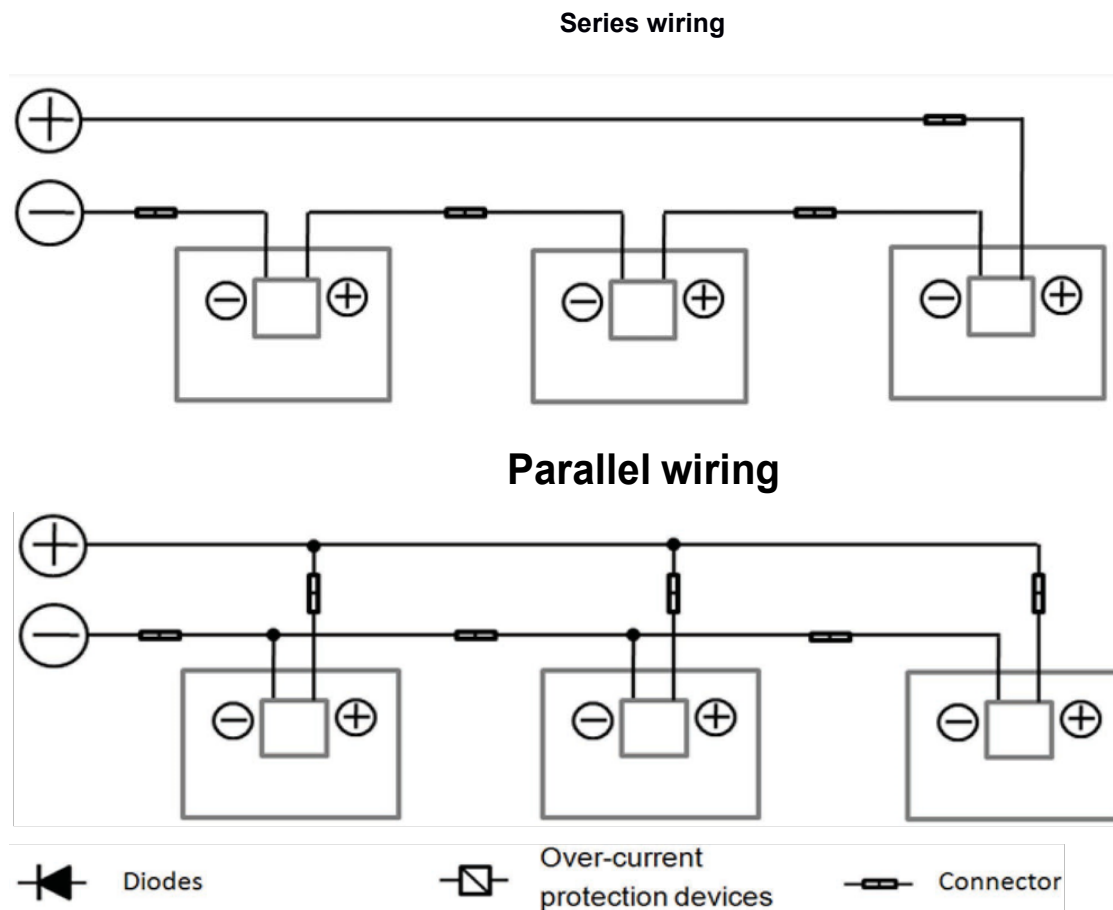

Figure 1: Electrical diagrams of series and parallel wiring.

The maximum number of Modules that can be connected in series within a string must be calculated in accordance with applicable regulations in such a way that the specified maximum system voltage (The maximum system voltage of bifacial module is DC 1500V) of the modules and all other electrical DC components will not be exceeded in open-circuit operation at the lowest temperature expected at the PV system location.

Correction factor for the open-circuit voltage can be calculated based on the following formula:  $C_{Voc}=[1-\alpha(25-T)]\%$ . T is the lowest expected ambient temperature at the system location.  $\alpha(\%/^{\circ}\text{C})$  is the temperature coefficient of the selected module  $V_{oc}$ (Refer to corresponding datasheet).

Dimension	Maximum system voltage	Maximum number of modules
1658×992×6mm	1500V	35
1968×992×6mm	1500V	29

*Note: The data above are calculated based on the temperature in Wuxi. The maximum number of modules that can be connected in series within a string for the specific project must be calculated based on the actual local temperature.*

If there is reverse current exceeding the maximum fuse current flowing through the module, use over-current protection device with the same specifications to protect it.

#### **Recommended installation method of full cell solar module:**

The modules in PV array are recommended for portrait connecting, and cable length is not less than 0.7 m.

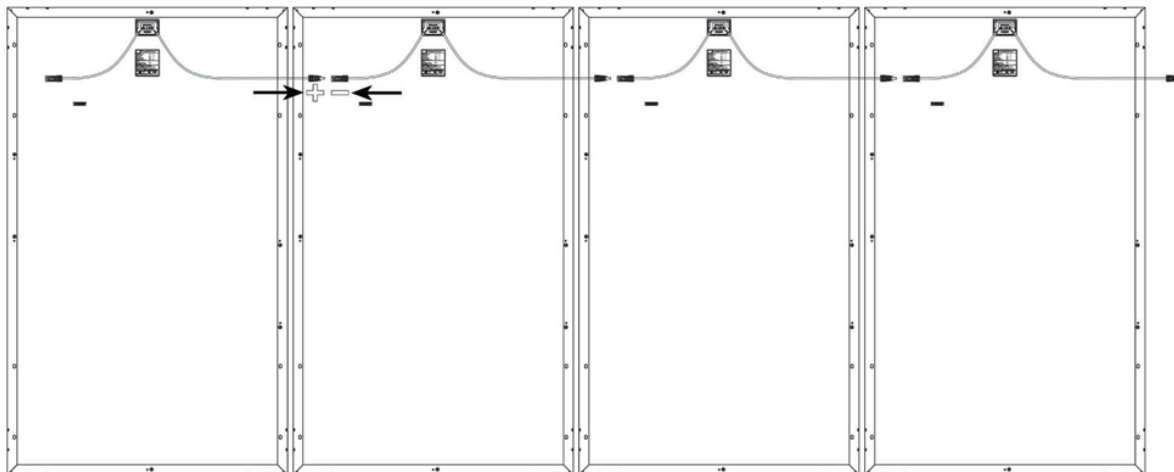

15

#### **Recommended installation method of half cell solar module:**

The head and tail of the modules in PV array are placed in a cross layout, and cable length is not less than 0.65 m.

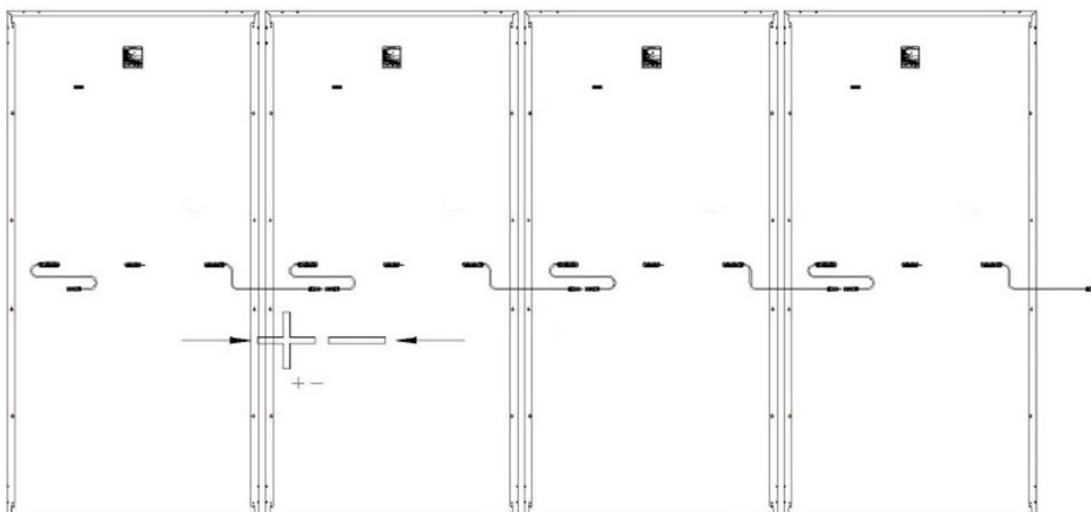



## 4.2. General installation

Any hardware used must be compatible with any other used material to avoid galvanic corrosion. Defects caused by corrosions void the warranty.

It is not recommended to use modules with different configurations (grounding, wiring) in the same system.

Excessive cables must be organized or fixed in an adequate way, e.g. attached to the mounting structure by using non-metallic cable ties. Solar cables, connectors and junction boxes should not be exposed to water exposure, and snow, and rain or water submersion for a long period of time (IP65/67/68).

For applications requiring high operating voltage several modules can be connected in series to form a string of modules; the system voltage is then equal to the sum of the voltage of each module.

For applications requiring high operating currents several strings of modules can be connected in parallel; the system current is then equal to the sum of the current of each string of modules. The maximum system voltage is 600 volts ,1000 volts or 1500 volts depending on the product family DC according to standards.

The maximum number of series connected modules depends on system design, the type of inverter used and environmental conditions.

Based on the maximum series fuse rating of module and local electrical installation code, always make sure München Solar PV modules are assembled with the appropriate string fuse for circuit protection.

There is no specific limitation on the number of modules that can be connected in parallel, the number of modules is determined by system design parameters such as current or power output. To prevent the cables and the connectors from overheating, the cross section of the cables and the capacity of the connectors must be selected to suit the maximum system short circuit current. The recommended cable is PV wire with a cross section of at least 4mm<sup>2</sup>.

Caution: do not secure the cables too tight. Any cable damage caused by cable management system is not covered under München Solar's warranty.

Always refer to the cable manufacturer's bending radius which includes the radius just behind the connectors.

When designing large modules arrays connected to a single inverter, always take into account the resulting isolation resistance (Riso), which decrease increasing the number of modules in the array. A too low Riso can results in inverter faults. Please refer to local regulations to determine the system wires size, type and temperature.

München Solar modules are supplied with connectors used for system electrical connections. The recommended connectors are

TL-CABLE01S connectors, Amphenol H4 connectors, Multi Contact MC4 connectors etc. München Solar

strongly recommends using the genuine connector type specified by München Solar's product data sheet. Any choice of a different connector type other than specified may void the warranty of the module.

To ensure reliable electric connection and to prevent possible intrusion of humidity, two connectors must be mated and locked together until a click can be heard.

Long-term exposure to wet environments may cause connectors' poor connectivity, resulting in current leakage and poor conductivity which voids the warranty. München Solar recommends proper connector/cable/wire management to prevent moisture intrusion. Depending on the amount of humidity, München Solar recommends periodic inspections of the installation system to maintain optimal module performance.

The DC current generated by photovoltaic systems can be converted into AC and fed into a public Grid. As local utilities' policies on connecting renewable energy systems to the Grids vary from region to region. Always seek the advice from a qualified system designer or integrator. Building permits, inspections and approvals by the local utility are generally required.

Especially for larger installations München Solar recommends lightning protection following the local requirements and regulations.

When the installation is finished and after connection to the grid please do a professional hand over to the owner including an installation protocol is required. Provide a clear documentation of the system to the owner consisting of following minimum data such as: user guide, system layout, data sheets, performance expectations, electrical system data e.g. a copy of the installation test report following minimum requirements of IEC 62446 / IEC 60364-6.

17

### **4.3. Grounding**

For grounding and bonding requirements, please refer to regional and national safety and electricity standards. If grounding is required, use a recommended connector type for the grounding wire.

For grounding, this guide refers to module frame grounding. If grounding is required, make sure module frames (metal exposed to touch) are always grounded.

München Solar recommends always refer to local state and national code requirements for PV module grounding. München Solar highly recommends negative grounding if it's allowed by local authorities.

When attaching the frame grounding hardware and wire to the frame it must be placed corresponding to the ground symbol stamped location to ensure proper electrical connection.

München Solar recommends one of the following parts for grounding:

- 1) Use M5 bolt and washer to bond the ground wire and aluminum frame through the grounding hole (as shown below). The tightening torque is 3-7Nm. All nuts and washers should be made of stainless steel. 4-14 mm<sup>2</sup> (AWG 6-12) exposed copper wire is recommended as groundwire.

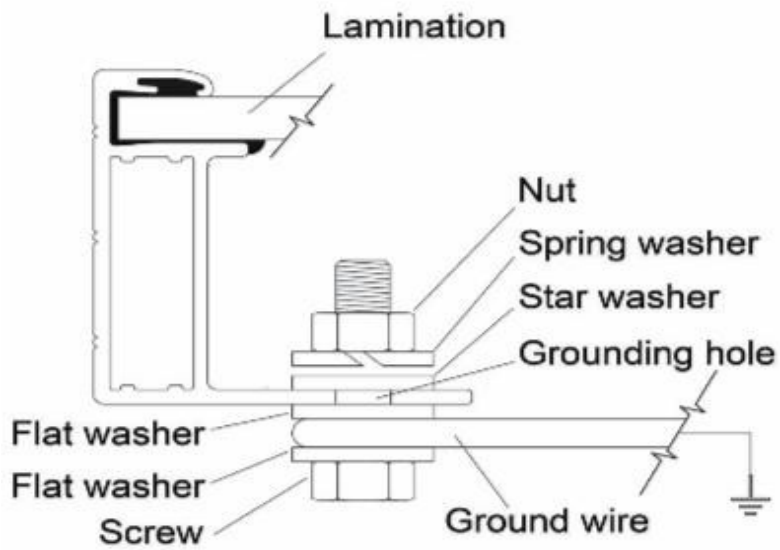

- 2) Use WEEB-DPF to bond solar modules to module mounting brackets (grounding part is tested to UL467)

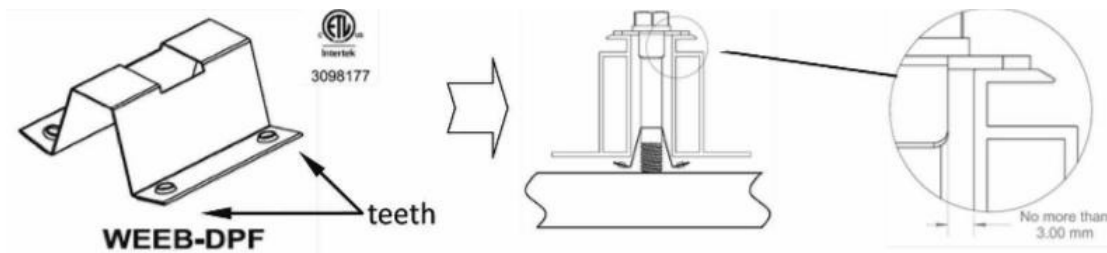

- 3) Use WEEB-DPF to bond solar modules to module mounting brackets (grounding part is tested to UL467)

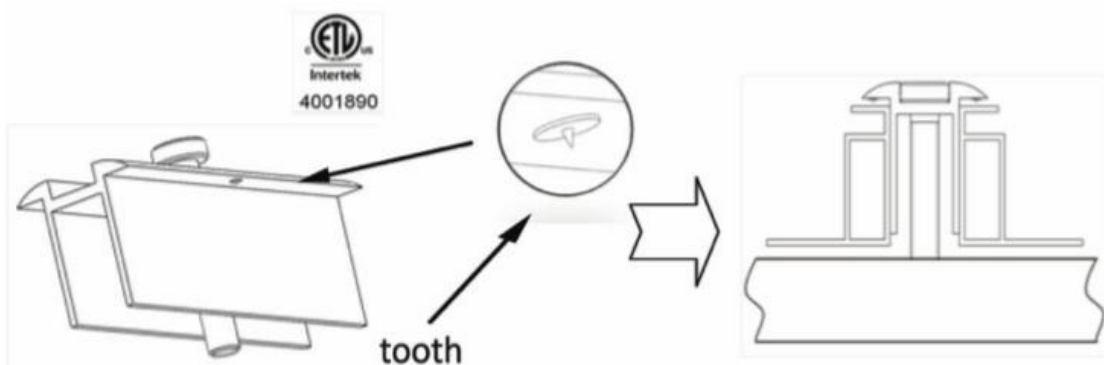

Recommend fastening torque is 20.5N-m/15 ft-lb.

## 5. Maintenance

To ensure optimum module performance, München Solar recommends the following maintenance measures:

- Clean the module minimum once a year or more often when required depending of the pollution. Remove all organic from the surface. Module with soiling or contamination may reduce the power generation of the system. Always use clean water and a soft non-abrasive sponge or cloth for cleaning. A mild, non-abrasive cleaning agent may be used to remove stubborn dirt.
- Uncontrolled pollution is voiding the warranty or not cleaning the modules in time voids the warranty.
- Check the electrical, grounding and mechanical connections every six months to verify that they are clean, secure, undamaged and free of corrosion. Or else the warranty may be voided.
- In the event of a ground fault condition, NEVER wash or spray modules with water until ground fault has been identified, corrected by an authorized solar inverter service technician and the inverter is fully operational. This can cause electrocution or a serious safety issue.
- If any problem arises, consult a professional solar service provider for suggestions.

*Caution: observe solar manufacturers' maintenance instructions for all components used in the system, such as support frames, charging regulators, inverters, batteries etc.*

19